

## Elegant Touch To Entry



high quality door handles



DH-20011 .....	HA4	PH-305S .....	HA26
DH-20021 .....	HA4	PH-4919-EHB001 .....	HA9
DH-20031 .....	HA4	PH-4920-EHB001 .....	HA9
DH-20041 .....	HA4	PH-4922-EHB002 .....	HA9
DH-20051 .....	HA4	PH-4924-EHB006 .....	HA9
DH-20061 .....	HA4	PHS-4926-EHB005 .....	HA10
DH-20211 .....	HA5	PHS-4930-EHB004 .....	HA10
DH-20221 .....	HA5	PHS-4960-EHB021 .....	HA11
DH-20231 .....	HA5	PK-4931-SBK801 .....	HA10
EHB001 .....	HA15	PL-4956-SB223 .....	HA11
EHB002 .....	HA15	PH-4958-EHB020 .....	HA11
EHB005 .....	HA15	PH-4960-EHB021 .....	HA11
EHB006 .....	HA15	PKS-EB-4924-SBK802 .....	HA9
EHB010 .....	HA16	PLS-4931-SB202-RH .....	HA10
EHB016-01 / 02 .....	HA16	PLS-4956-SB223 .....	HA11
EHB016A-01 / 02 .....	HA16	PS-4919 .....	HA9
EHB017 .....	HA16	PS-4920 .....	HA9
EHB018 .....	HA17	PS-4930 .....	HA10
EHB019 .....	HA17	PS-4958 .....	HA11
EHB020 .....	HA17	PS-EA-4926 .....	HA10
EHB021 .....	HA17	PS-EE-4922 .....	HA9
EHZ001 .....	HA20	SD1-A .....	HA5
EHZ002 .....	HA20	SD1 / SD2 / SD3 / SD4 .....	HA5
EHZ003 .....	HA20	SE19 .....	HA24
EHZ004 .....	HA20	SEA19 .....	HA24
EHZ005 .....	HA21	SH19 .....	HA24
EHZ006 .....	HA21	SHA19 .....	HA24
EHZ007 .....	HA21	Fixing Method - Brass Series .....	HA14
EHZ008 .....	HA21	Fixing Method - DH / SD Series .....	HA8
EHZ009 .....	HA21	Fixing Method - EHB Series .....	HA19
P-165S .....	HA25	Fixing Method - EHZ Series .....	HA23
P-280S .....	HA25	Product Information - Brass Series .....	HA13
P-295S .....	HA25	Letters-Plate with Engraved Letters - Brass Series .....	HA14
P-305S .....	HA26	How to Order - Brass Series .....	HA14
PH-165 .....	HA25	Finishes .....	HA27-29
PH-165S .....	HA25		
PH-280 .....	HA25		
PH-280S .....	HA25		
PH-295 .....	HA25		
PH-295S .....	HA25		
PH-305 .....	HA26		

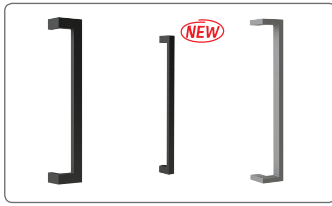

DH / SD Series - Door Handles

HA4-8



Brass Series - Push & Pull Plate with Handle

HA9-14



EHB Series - Door Handles

HA15-19

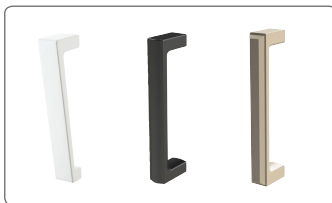

EHZ Series - Door Handles

HA20-23



SE / SH Series - Pull Handles

HA24



P / PH Series - Push Plate & Pull Handles with Plate

HA25-26

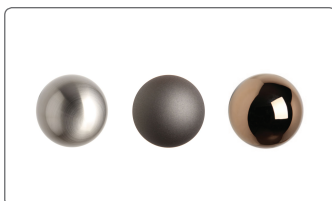

Finishes

HA27-29

# DH SERIES

Door Handles

Finishes : F24, F25, F91~F102, F91T~F108T,  
PVD (by request)  
Materials : Stainless Steel  
Fixing Method : J, K, X Type

**DH-20011**

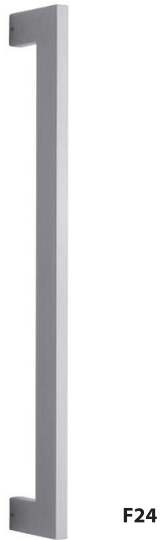

F24

**DH-20021**

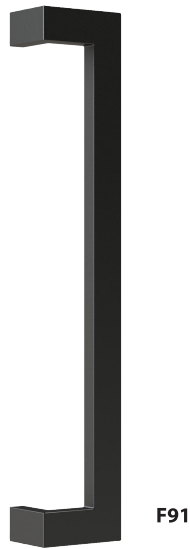

F91

**DH-20031**

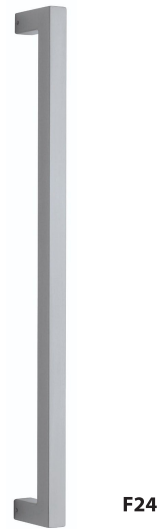

F24

**DH-20041**

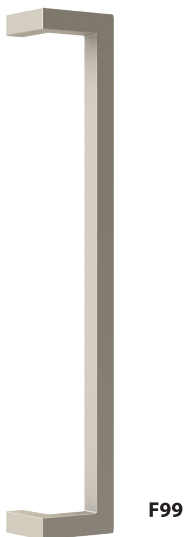

F99

**DH-20051**

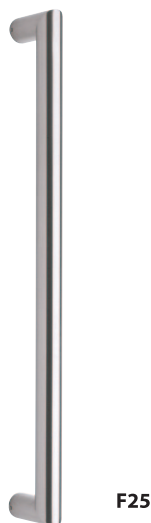

F25

**DH-20061**



F93

# DH / SD SERIES

Door Handles

Finishes : F24, F25, F91~F102, F91T~F108T,  
PVD (by request)  
Materials : Stainless Steel  
Fixing Method : J , K , X Type

**DH-20211**



F24

**DH-20221**



F96T

**DH-20231** **NEW**



F91T

**SD1-A**



F97

Only Y Type Fixing Method

**SD1 / SD2 / SD3 / SD4**



F25

Only Y Type Fixing Method

# DH / SD SERIES

Dimensions  
in millimeters



**DH-20011**

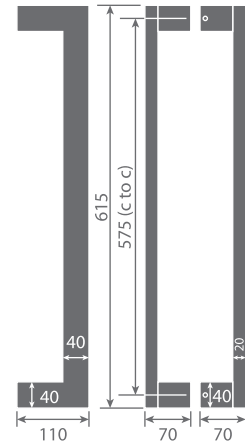

**DH-20021**

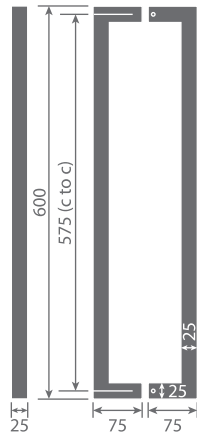

**DH-20031**

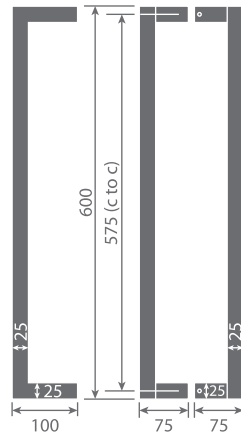

**DH-20041**

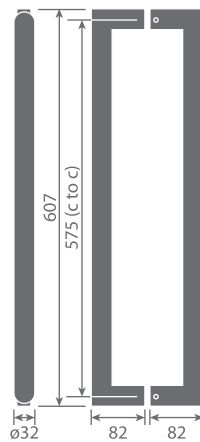

**DH-20051**

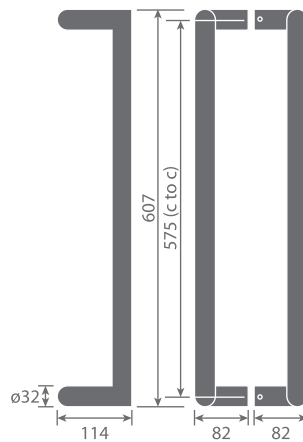

**DH-20061**

# DH / SD SERIES

Dimensions in millimeters

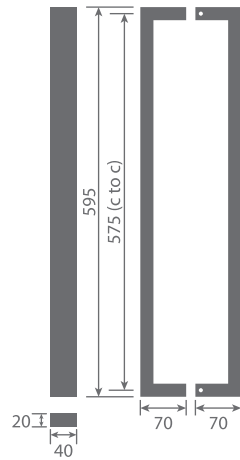

DH-20211

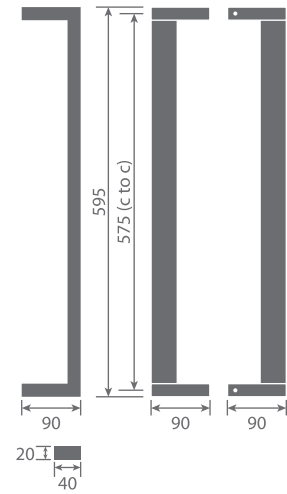

DH-20221

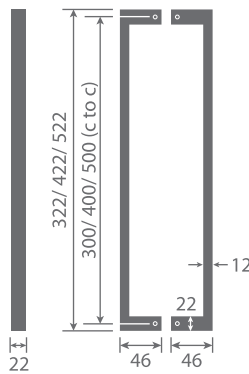

DH-20231 **NEW**

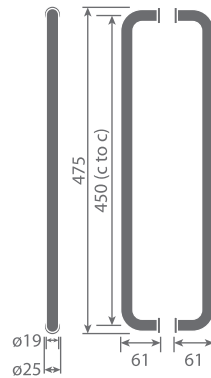

SD1-A

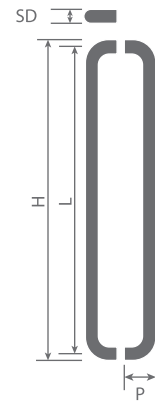

SD1 / SD2 / SD3 / SD4

SD (DIA.)		L (C to C)	H (HEIGHT)	P (PROJECTION)
SD1-X	19mm	152mm	171mm	57mm
SD1-Y		230mm	249mm	
SD1-K		300mm	319mm	
SD1-J				
SD2-X	25mm	300mm	325mm	63mm
SD2-Y		457mm	482mm	
SD2-K		600mm	625mm	
SD2-J				
SD3-X	32mm	300mm	332mm	70mm
SD3-K		457mm	489mm	
SD3-J		600mm	632mm	
SD4-X	38mm	300mm	338mm	76mm
SD4-K		457mm	495mm	
SD4-J		600mm	638mm	

## Fixing Method

### X TYPE = BACK TO BACK FIXING (DOUBLE HANDLES)

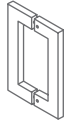

DH20011-X

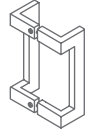

DH20021-X

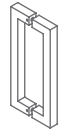

DH20031-X

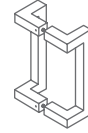

DH20041-X

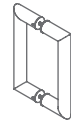

DH20051-X

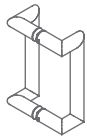

DH20061-X



DH20211-X



DH20221-X



DH20231-X **NEW**



SD1A



SD1~SD-4

### Y TYPE = BACK FIXING WITH SCREW CAP



SD1-A



SD1



SD2



SD3



SD4

### K TYPE = FACE FIXING



DH20011-K

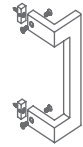

DH20021-K



DH20031-K



DH20041-K



DH20051-K

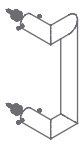

DH20061-K



DH20211-K



DH20221-K



DH20231-K **NEW**



SD1~SD-4

### J TYPE = BACK FIXING



DH20011-J



DH20021-J

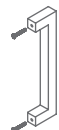

DH20031-J



DH20041-J

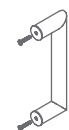

DH20051-J



DH20061-J



DH20211-J



DH20221-J



SD1-A



SD1~SD-4



# BRASS SERIES

Push & Pull Plate  
with Handle

This series is available in all finishes:

F21, F22, F91~F102, F91T~F108T,  
PVD (by request).

Engraved letterings are available for the  
electroplating finishes (F21, F22, PVD).

**PH-4919-EHB001**

**PS-4919**



**F100**



**F100**

**PH-4920-EHB001**

**PS-4920**



**F101**



**F101**

**PH-4922-EHB002**

**PS-EE-4922**

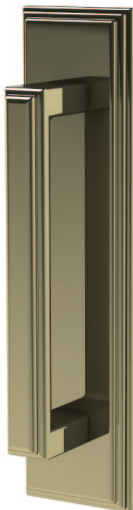

**F16**



**F21**

**PH-4924-EHB006**

**PKS-EB-4924-  
SBK802**



**F99**



**F21**

**PHS-4926-EHB005**

**PS-EA-4926**



**F22**



**F22**

**PHS-4930-EHB004**

**PS-4930**



**F21**



**F21**

**PK-4931-SBK801**

**PLS-4931-SB202-RH**



**F102**



**F102**

**PL-4956-SB223**

**PLS-4956-SB223**



**F91**



**F91**

**PH-4958-EHB020**

**PS-4958**



**F21**



**F21**

**PH-4960-EHB021**

**PHS-4960-EHB021**



**F94T**



**F94T**

# BRASS SERIES

Dimensions  
in millimeters

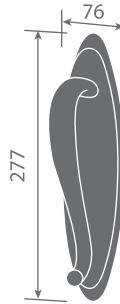

**PH-4919-  
EHB001**



**PS-4919**

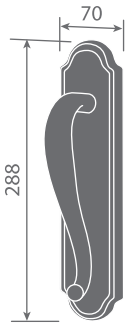

**PH-4920-  
EHB001**



**PS-4920**

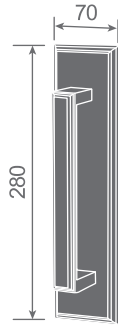

**PH-4922-  
EHB002**



**PS-EE-4922**

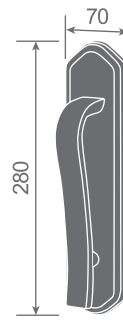

**PH-4924-  
EHB006**



**PKS-EB-4924-  
SBK802**

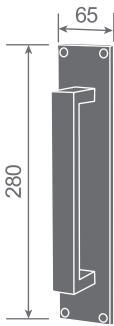

**PHS-4926-  
EHB005**



**PS-EA-4926**

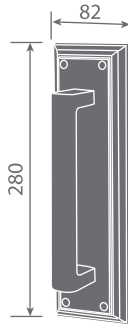

**PHS-4930-  
EHB004**



**PS-4930**

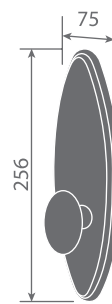

**PK-4931-  
SBK801**

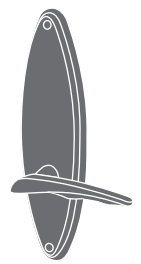

**PLS-4931-  
SB202-RH**

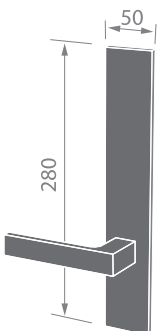

**PL-4956-  
SB223**

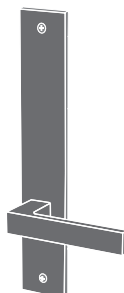

**PLS-4956-  
SB223**

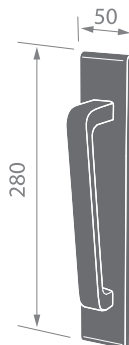

**PH-4960-  
EHB021**



**PHS-4960-  
EHB021**

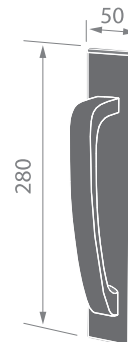

**PH-4958-  
EHB020**



**PS-4958**

## Product Information

<b>P</b> Plate (Back Fixing)	
	P-4919   P-4920   P-4922   P-4924   P-4926   P-4930   P-4931   P-4956   P-4958   P-4960

<b>PS</b> Plate (Surface Fixing)	
	PS-4919   PS-4920   PS-4922   PS-4924   PS-4926   PS-4930   PS-4931   PS-4956   PS-4958   PS-4960

<b>PH</b> Plate with Handle (Back Fixing)		<b>PHS</b> Plate with Handle (Surface Fixing)		
				EHB001   EHB002   EHB005   EHB006   EHB010   EHB017   EHB019   EHB020   EHB021

<b>PK</b> Plate with Knob (Back Fixing)		<b>PKS</b> Plate with Knob (Surface Fixing)		
				SBK-801   SBK-802   SBK-803   SBK-804   SBK-805   SBK-806

<b>PL</b> Plate with Lever (Back Fixing)		<b>PLS</b> Plate with Lever (Surface Fixing)		LH	RH	
						SB201   SB202   SB203   SB204   SB205 SB206   SB207   SB208   SB209   SB210 SB211   SB212   SB213   SB214   SB215 SB216   SB217   SB219   SB220   SB221 SB222   SB223   SB225   SB226

## Fixing Method

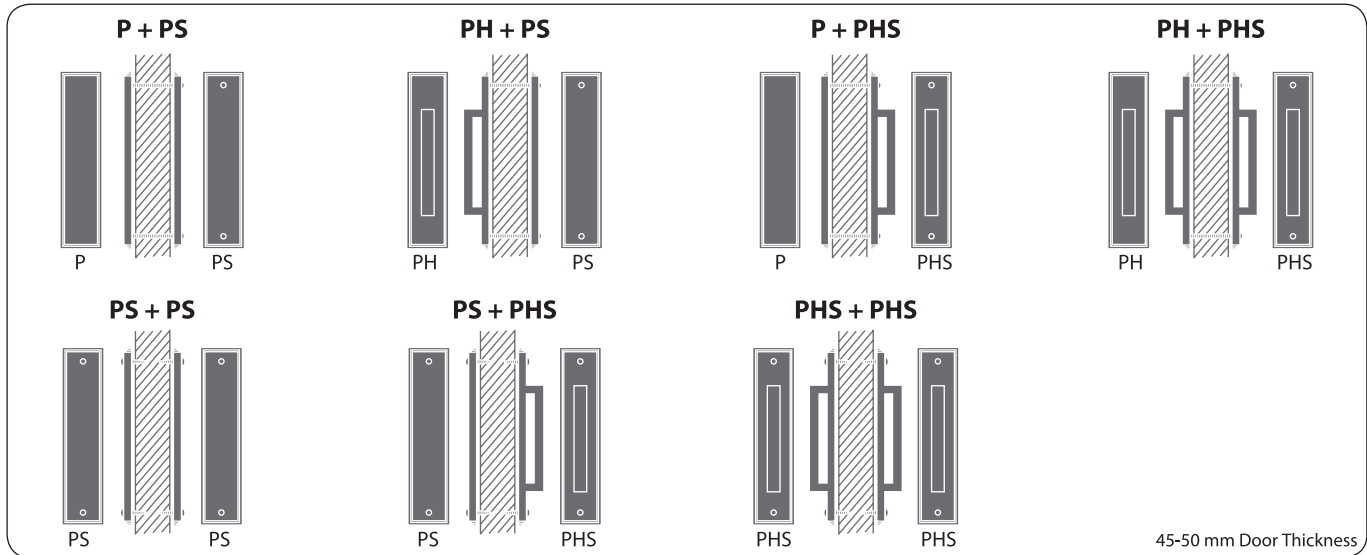

## Letters - Plate with Engraved Letters

**Engraved Letters**

EA	EB	EE	EF	EG

## How to Order

	<b>PS</b>	<b>EA</b>	<b>4926</b>	<b>F22</b>		<b>PLS</b>	<b>4931</b>	<b>SB202</b>	<b>RH</b>	<b>F100</b>
	Plate (Surface Fixing)	Engraved Letter	Plate Model	Finish			Plate with Lever (Surface Fixing)	Plate Model	Lever Handle	Right Hand
	<b>PHS</b>	<b>4930</b>	<b>EHB004</b>	<b>F21</b>		<b>PH</b>	<b>4920</b>	<b>EHB001</b>	<b>F99</b>	
	Plate with Handle (Surface Fixing)	Plate Model	Handle	Finish			Plate with Handle (Back Fixing)	Plate Model	Handle	Finish

# EHB SERIES

Door Handles

Finishes : F21, F22, F91~F102, F91T~F108T,  
PVD (by request)  
Material: Solid Brass  
Fixing Method: J, K, X, Y Type

## EHB001



F97

F101

F94T

## EHB002



F22

F16

F100

## EHB005



F91

F96T

F102

## EHB006

Only Y, J Type  
Fixing Method



F99

F21

F91

**EHB010**



F101

F97

F106T

**EHB017**



F97

F304

F104T

**EHB016-01**

C to C=203mm



F22

F102T

**EHB016-02**

C to C=254mm



F21

F99

**EHB016A-01**

C to C=203mm



F100

F21

**EHB016A-02**

C to C=254mm



F91

F93



**EHB018**



F21

F93

F91

**EHB019**



F97

F100

F108T

**EHB020**



F21

F311

F102

**EHB021**



F22

F101

F96T

# EHB SERIES

Dimensions in millimeters

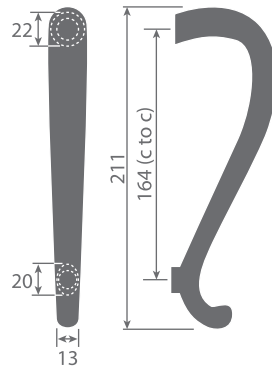

**EHB001**

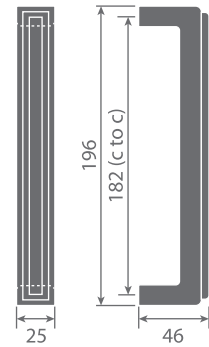

**EHB002**

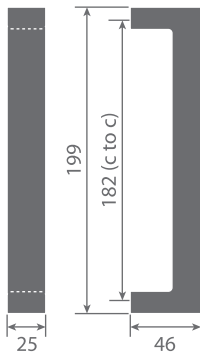

**EHB005**

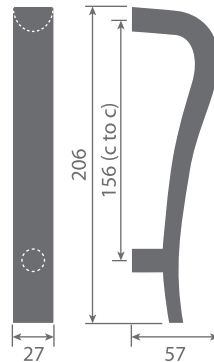

**EHB006**

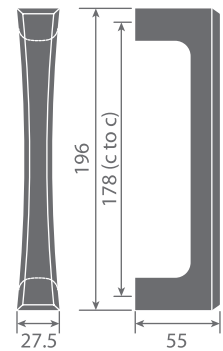

**EHB010**

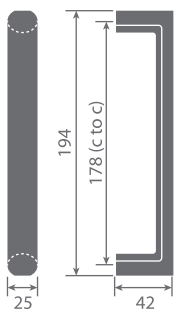

**EHB017**



**EHB016-01/02**

01 = 226mm 02 = 277mm

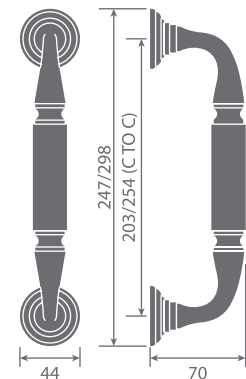

**EHB016A-01/02**

01 = 247mm 02 = 298mm

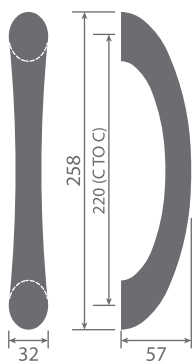

**EHB018**

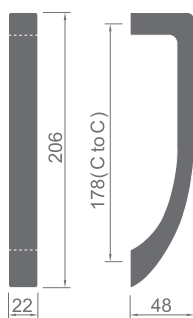

**EHB019**

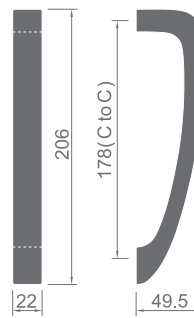

**EHB020**

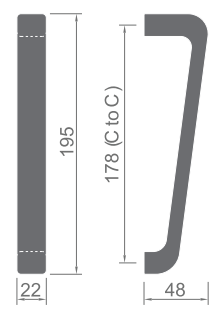

**EHB021**

## Fixing Method

### X TYPE = BACK TO BACK FIXING (DOUBLE HANDLES)

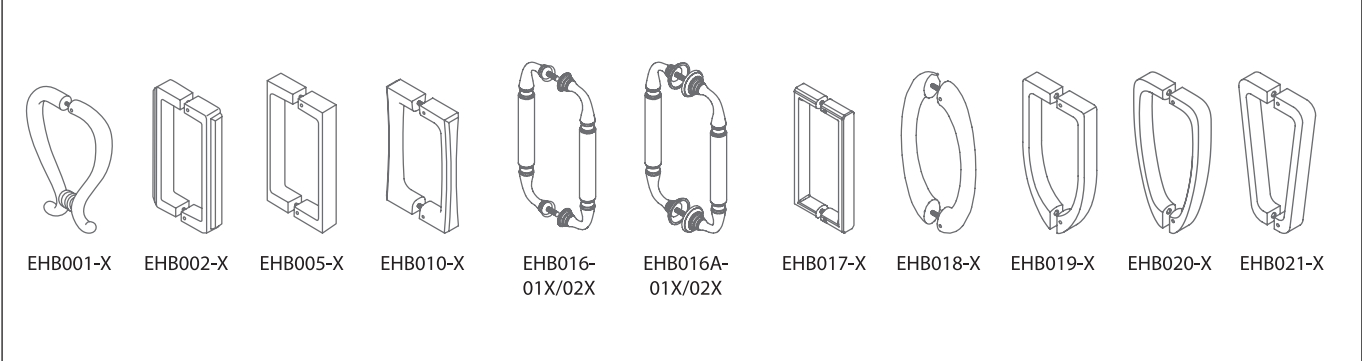

### Y TYPE = BACK FIXING WITH SCREW CAP

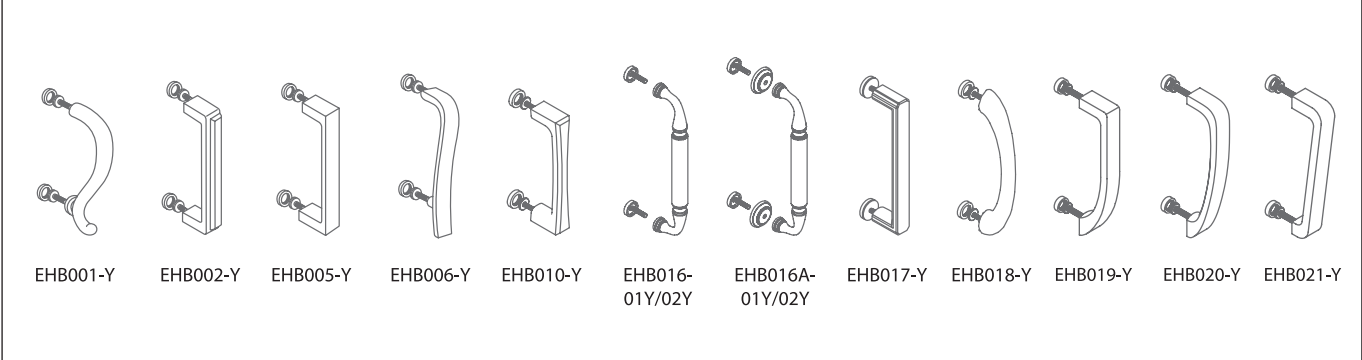

### K TYPE = FACE FIXING

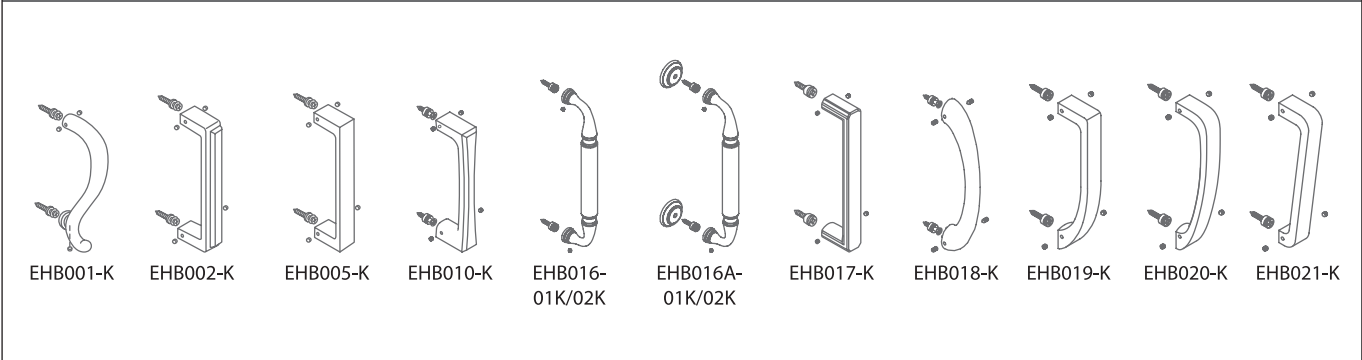

### J TYPE = BACK FIXING

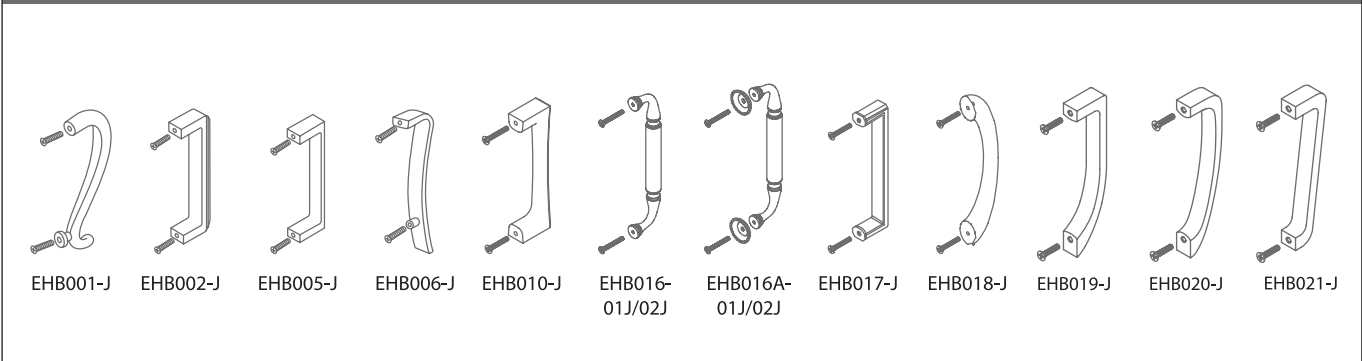

# EZH SERIES

Door Handles

Finishes : F21, F22, F91~F102, F91T~F108T,  
PVD (by request)

Material: Zinc Alloy

Fixing Method: J, K, X, Y Type

## EZH001

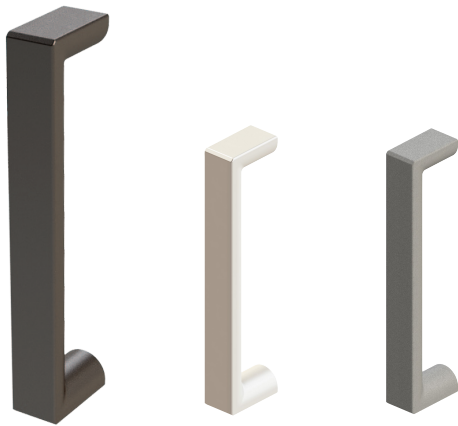

F97

F99

F96T

## EZH002



F91

F101

F106T

## EZH003



F21

F105T

F100

## EZH004



F21

F91

F104T

**EHZ005**

Only Y, J Type  
Fixing Method



**F21**



**F93**



**F102**

**EHZ006**

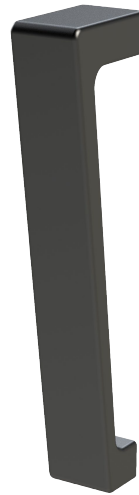

**F91**



**F107T**



**F93**

**EHZ007**



**F96T**



**F97**

**EHZ008**



**F91**



**F108T**

**EHZ009**

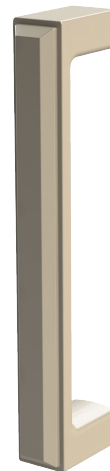

**F101**

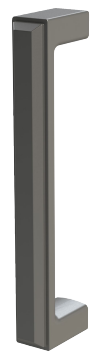

**F100**

# EZH SERIES

Dimensions  
in millimeters

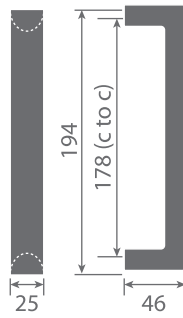

**EZH001**

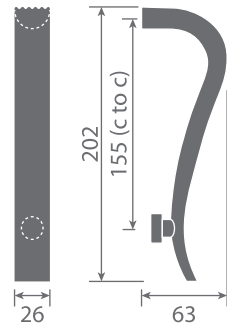

**EZH002**

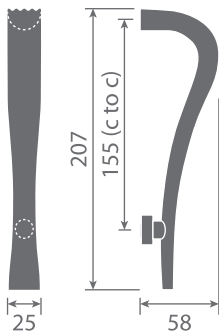

**EZH003**

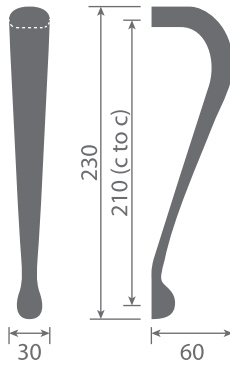

**EZH004**

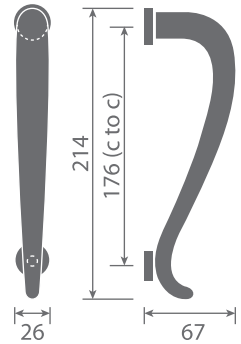

**EZH005**

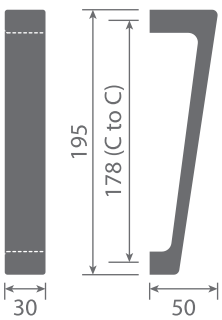

**EZH006**

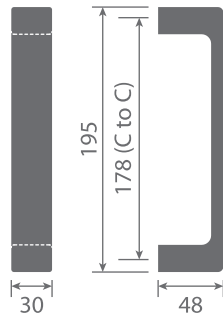

**EZH007**

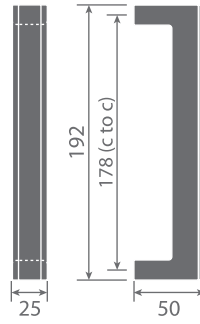

**EZH008**

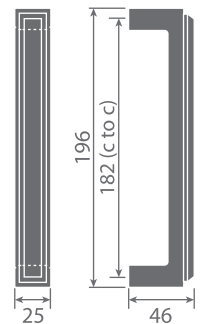

**EZH009**

# Fixing Method

## X TYPE = BACK TO BACK FIXING (DOUBLE HANDLES)

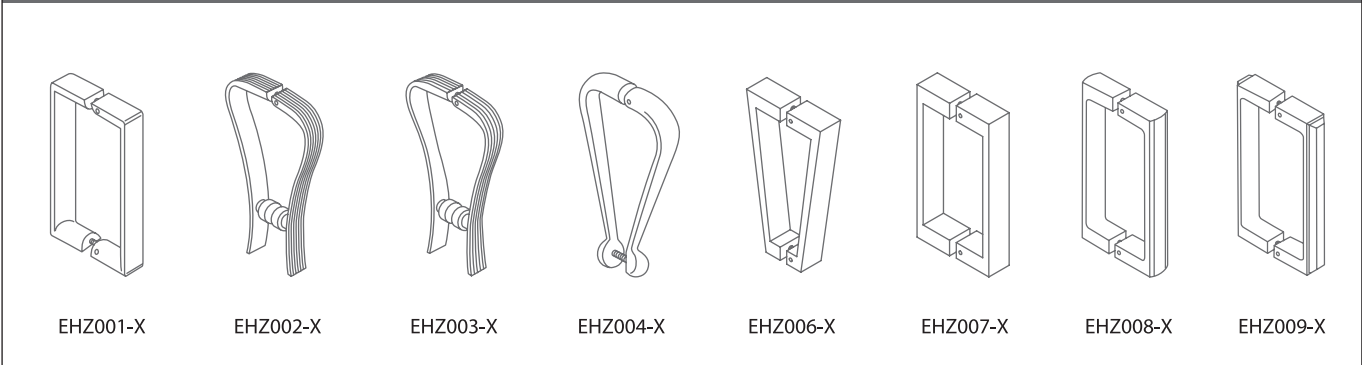

## Y TYPE = BACK FIXING WITH SCREW CAP

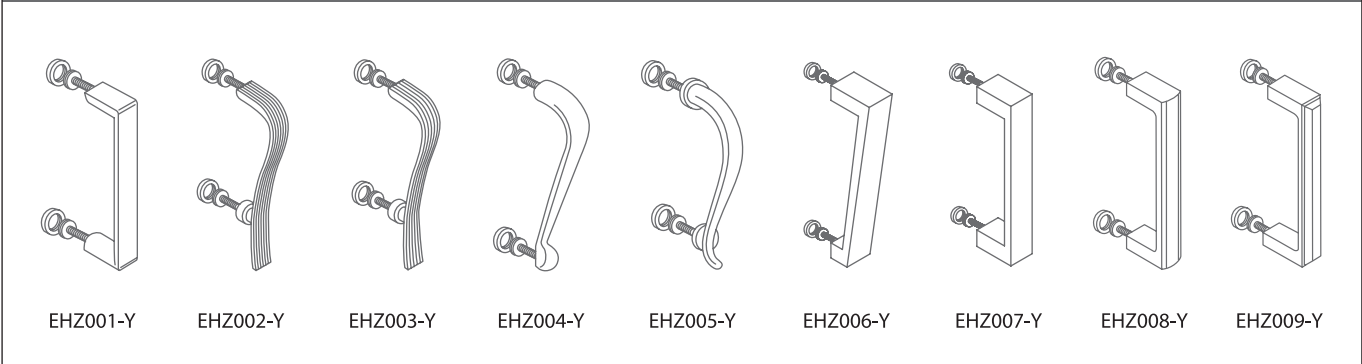

## K TYPE = FACE FIXING

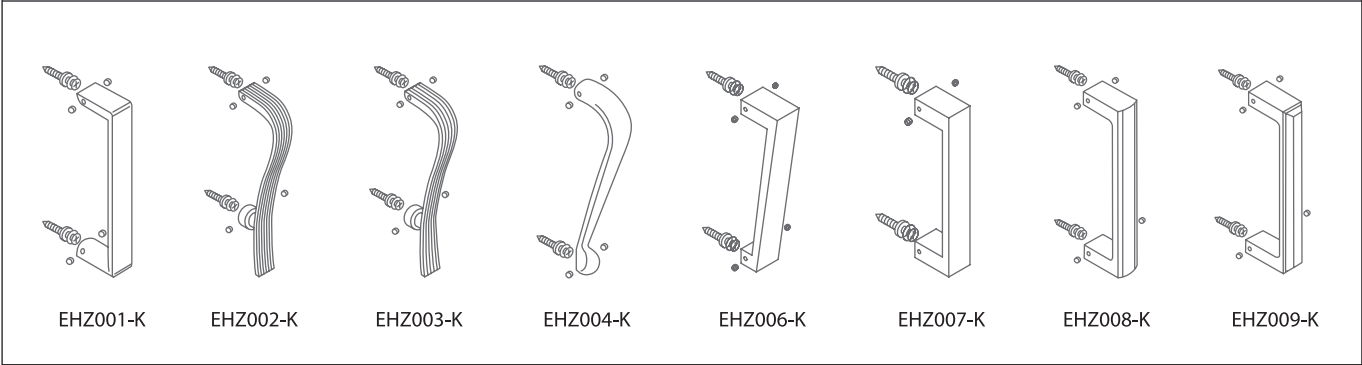

## J TYPE = BACK FIXING

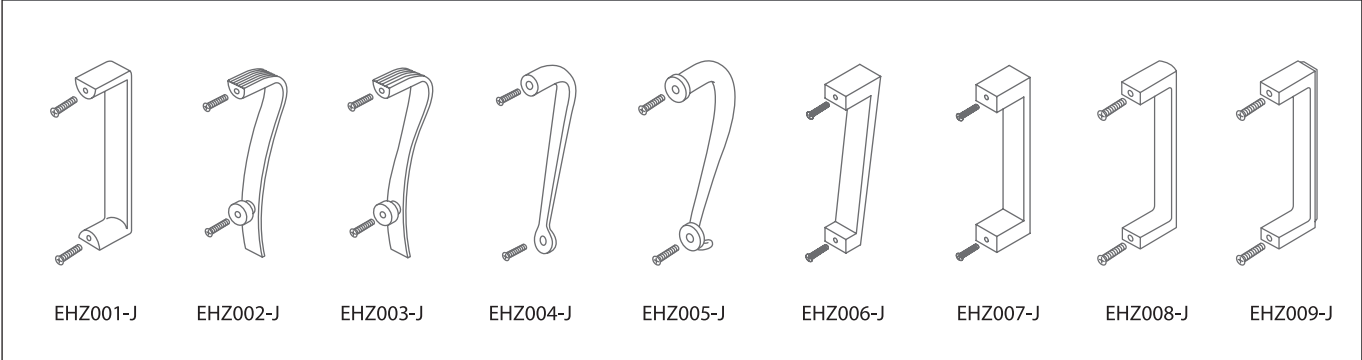

# SE / SH SERIES

Pull Handles

Finishes : F24, F25, F91~F102, F91T~F108T,  
PVD (by request)  
Materials : Stainless Steel

**SE19**



**F97**

**SEA19**



**F25**

**SH19**



**F25**

**SHA19**



**F99**

# SE / SH SERIES

Dimensions  
in millimeters

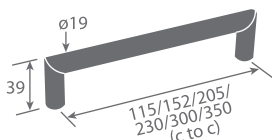

**SE19**

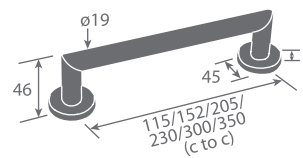

**SEA19**

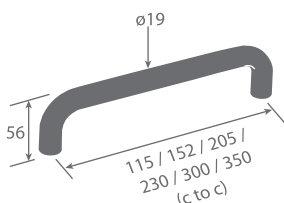

**SH19**

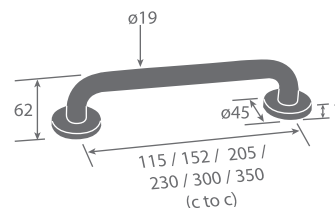

**SHA19**



# P / PH SERIES

Push Plate & Pull Handles with Plate

This series is available in all finishes :  
F24, F25, F91~F102, F91T~F108T,  
PVD (by request).

Laser engraved letters are available for  
various finishes :  
F24, F25, F91, F93, F97, F100, F102,  
F105T, F107T, PVD (by request).

Materials : Stainless Steel  
Plate thickness : 1.5mm



(with Laser engraved letters)  
(Letters are by customers request)

## P-165S

Push plate



F24

## PH-165

Pull handle with plate



F24

## PH-165S

Pull handle with plate



F25

## P-280S

Push plate



F97

## PH-280

Pull handle with plate



F97

## PH-280S

Pull handle with plate



F97

## P-295S

Push plate



F24

## PH-295

Pull handle with plate



F24

## PH-295S

Pull handle with plate



F25



**P / PH  
SERIES**

Dimensions  
in millimeters

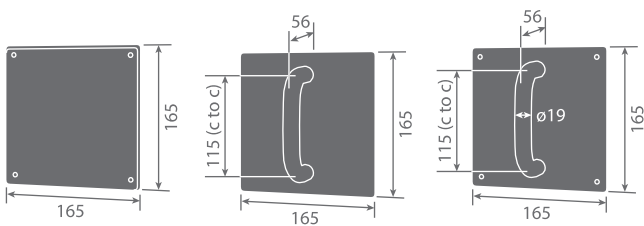
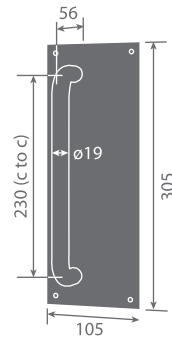

**P-165S**

**PH-165**

**PH-165S**

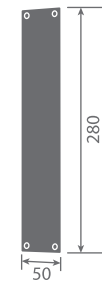

**P-280S**

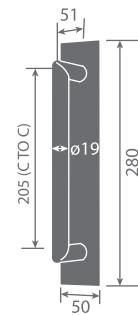

**PH-280**

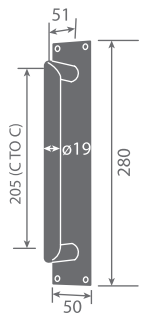

**PH-280S**

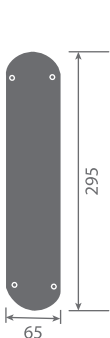

**P-295S**

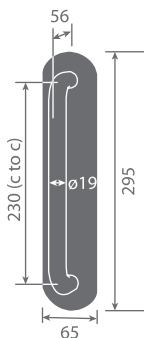

**PH-295**

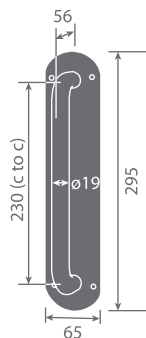

**PH-295S**



**P-305S**

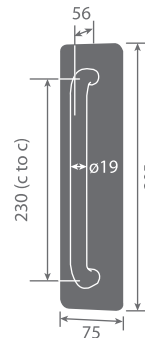

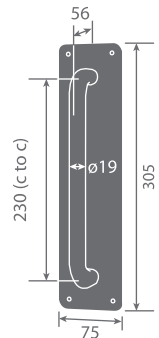

**PH-305**





**PH-305S**





## Electroplate Finishes List

BONCO	Description	BONCO	Description
	<b>F21</b> Bright chrome		<b>F22</b> Satin nickel

## SUS Finishes List

BONCO	Description	BONCO	Description
	<b>F24</b> Satin stainless steel		<b>F25</b> Polished stainless steel

## BPC Finishes List

BONCO	Description	BONCO	Description
	<b>F91</b> Matt black powder coating		<b>F91T</b> Matt black powder coating with rough surface
	<b>F93</b> Matt white powder coating		<b>F93T</b> Matt white powder coating with rough surface

## A Graceful And Contemporary Feel

<b>BONCO</b>	<b>Description</b>	<b>BONCO</b>	<b>Description</b>
	<b>F94T</b> Matt light grey powder coating with rough surface		<b>F96T</b> Matt dark grey powder coating with rough surface
	<b>F97</b> Matt brown powder coating		<b>F97T</b> Matt brown powder coating with rough surface
	<b>F99</b> Matt champagne silver powder coating		<b>F100</b> Matt silver grey powder coating
	<b>F100T</b> Matt silver grey powder coating with rough surface		<b>F101</b> Matt champagne gold powder coating
	<b>F102</b> Matt antique brass gold powder coating		<b>F102T</b> Matt antique brass gold powder coating with rough surface
	<b>F104T</b> Matt light green powder coating with rough surface		<b>F105T</b> Matt dark green powder coating with rough surface
	<b>F106T</b> Matt light blue powder coating with rough surface		<b>F107T</b> Matt dark blue powder coating with rough surface
	<b>F108T</b> Matt rose gold powder coating with rough surface		

## PVD Finishes List

<b>BONCO</b>	<b>Description</b>	<b>BONCO</b>	<b>Description</b>
	<b>F16</b> Polished brass		<b>F17</b> Brushed brass
	<b>F301</b> Polished bronze		<b>F302</b> Brushed bronze
	<b>F303</b> Brushed chrome		<b>F304</b> Red gold
	<b>F305</b> Brushed red gold		<b>F306</b> Polished black chrome
	<b>F307</b> Brushed black chrome		<b>F308</b> Steel optic
	<b>F310</b> Polished nickel		<b>F311</b> Gold optic
	<b>F316</b> Brushed nickel		



Name of quality & dependability

[www.boncohardware.com](http://www.boncohardware.com)

**BONCO** Ironmongery Ltd.  
A Member of E. Bon Holdings (HKEx stock code 599)

---

16/F, First Commercial Building, 33 Leighton Rd., Causeway Bay, H.K.  
Tel : (852) 2891 2188 Fax : (852) 2834 2652

